

# RAVENNA No1

Οδηγίες Εγκατάστασης  
Installation Manual

---











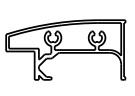

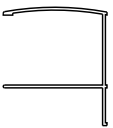
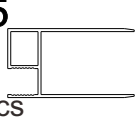

## Απαραίτητα εργαλεία Tools required

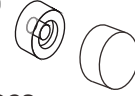
Περιγραφή Description	Εικόνα Image	Περιγραφή Description	Εικόνα Image
Μέτρο Tape measure		Δράπανο Drill	
Αλφάδι Spirit level		Σταυροκατσαβίδο Screwdriver	
Μολύβι Pencil		Ματσόλα Mallet	
Τρυπάνι Ø6mm Ø6mm Drill bit		Σιλικόνη Silicone Sealant	
Τρυπάνι Ø3mm Ø3mm Drill bit		Γάντια Gloves	
Γυαλιά προστασίας Protection eyeglasses			

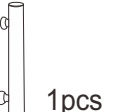

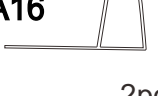
Το προϊόν είναι βαρύ και μπορεί να απαιτούνται δύο άτομα για την εγκατάσταση.  
This product is heavy and may require two people to install.

<b>A1</b>  1pcs	<b>A2</b>  2pcs	<b>A3</b>  4X10 6pcs	<b>A4</b>  2pcs
<b>A5</b>  1pcs	<b>A6</b>  1pcs	<b>A7</b>  6pcs	<b>A8</b>  4X30 10pcs
<b>A9</b>  12pcs	<b>A11</b>  Ø 3mm 1pcs	<b>A12</b>  4X20 4pcs	<b>A13</b>  1pcs
<b>A15</b>  2pcs	<b>A16</b>  2pcs	<b>A17</b>  2pcs	

### Σημείωση

- α. Διαβάστε τις οδηγίες προσεκτικά πριν την εγκατάσταση. Ελέγξτε όλα τα παρελκόμενα βάσει της λίστας. Προετοιμάστε τα εργαλεία που θα χρειαστείτε και τοποθετήστε το προϊόν ακολουθώντας τις οδηγίες.
- β. Χειριστείτε το κρύσταλλο προσεκτικά. Ζητήστε βοήθεια από δεύτερο άτομο εάν χρειάζεστε. Χρησιμοποιήστε ματσόλα κατά την τοποθέτηση. Για προστασία του κρυστάλλου μην χρησιμοποιείτε σκληρά εργαλεία ή αντικείμενα για να χτυπήσετε τα κρύσταλλα.
- Δείξτε μεγάλη προσοχή στις γωνίες των κρυστάλλων!**

### Installation Notice

- a. Read this installation manual carefully before installation. Check all fittings according to the fitting list. Prepare all parts and tools needed and install the product following the installation procedures.
- b. Handle the glass gently. Ask some body for help if needed. Use rubber hammer to knock if necessary while installing. To protect the glass from being destroyed, do not use something hard to knock the glass, especially knock the corner of the glass.

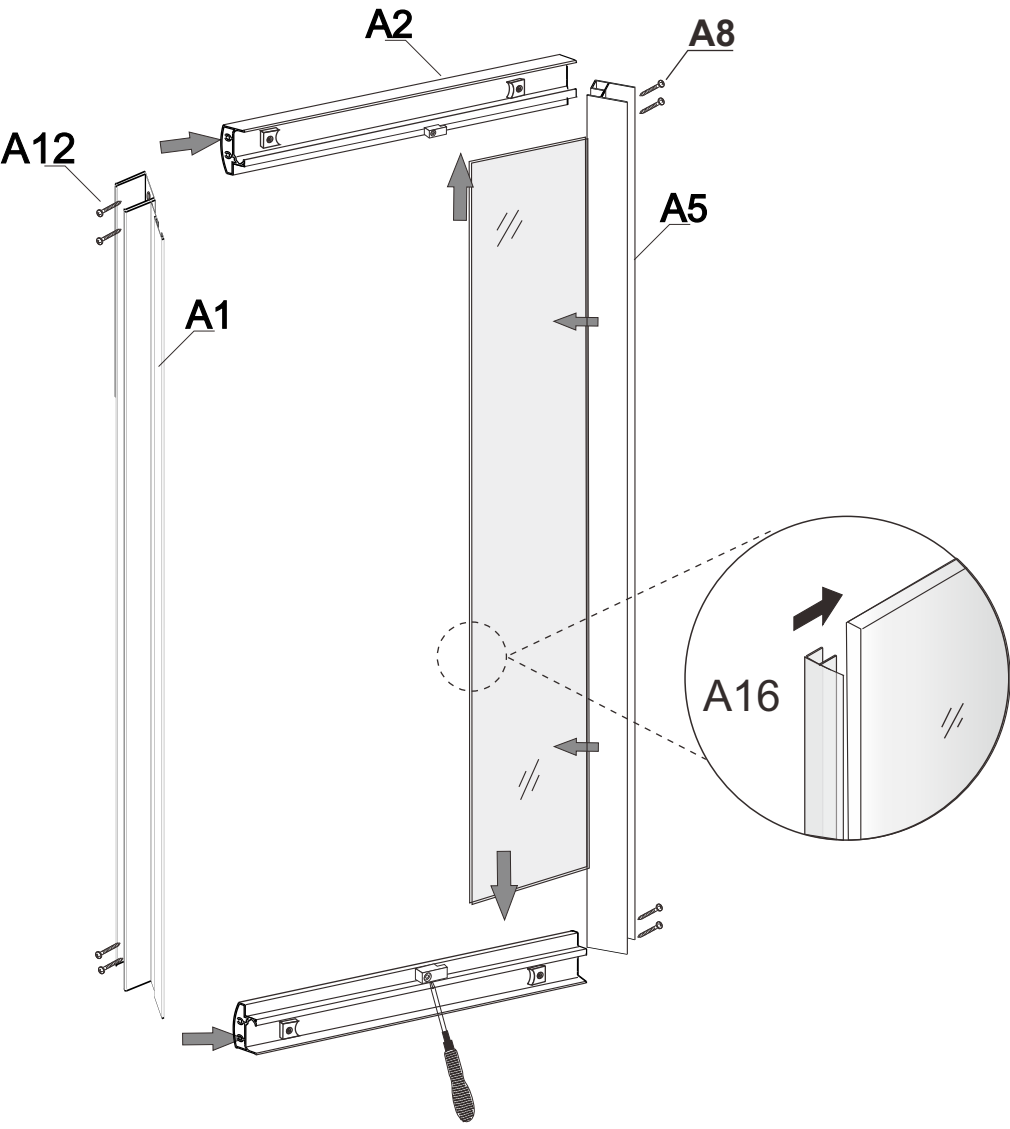
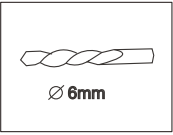
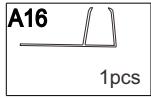
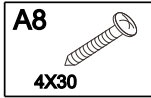
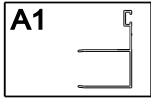
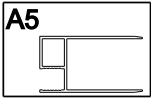
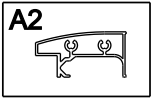

3

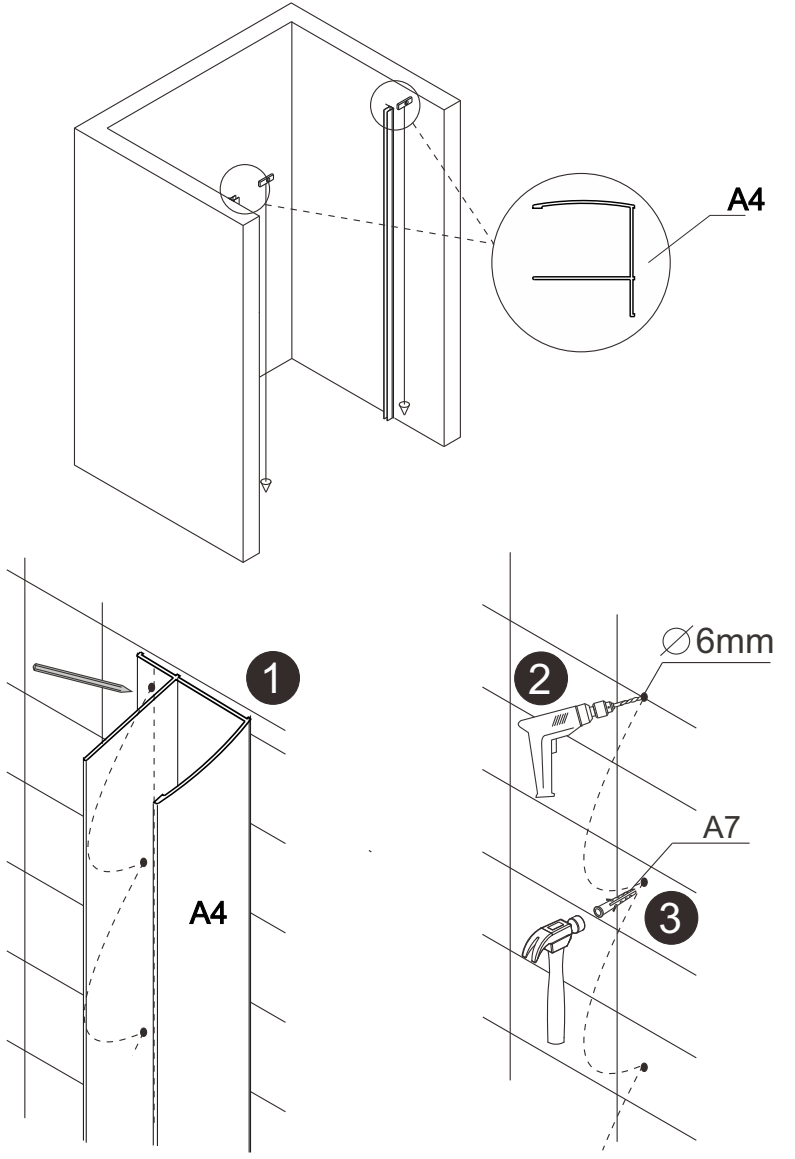

4

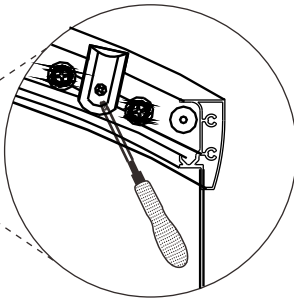
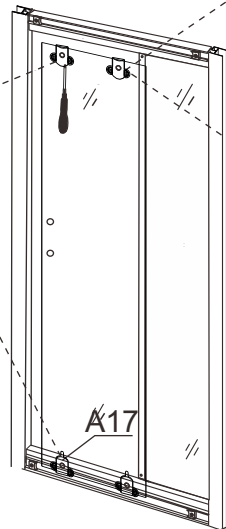
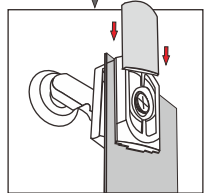
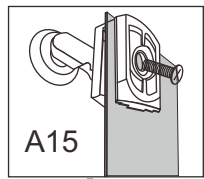
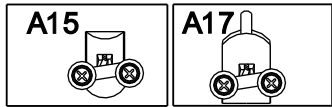
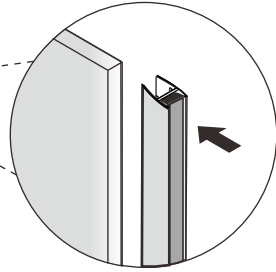
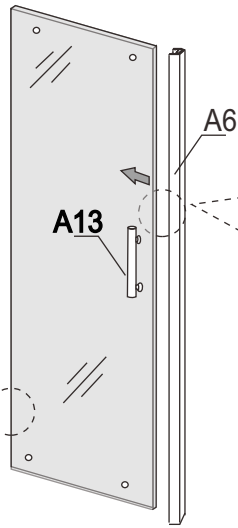
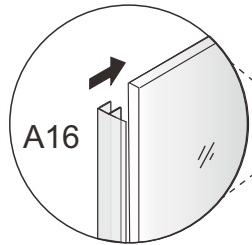
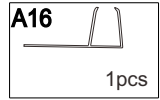
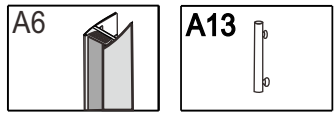

5

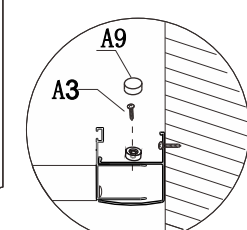
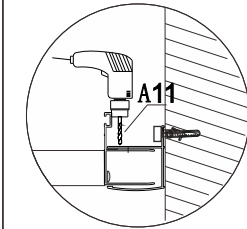
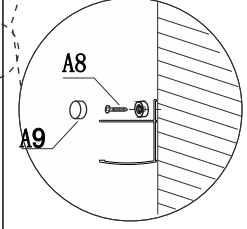
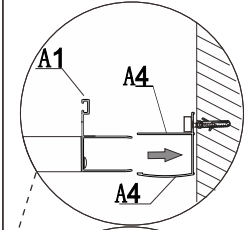
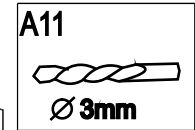
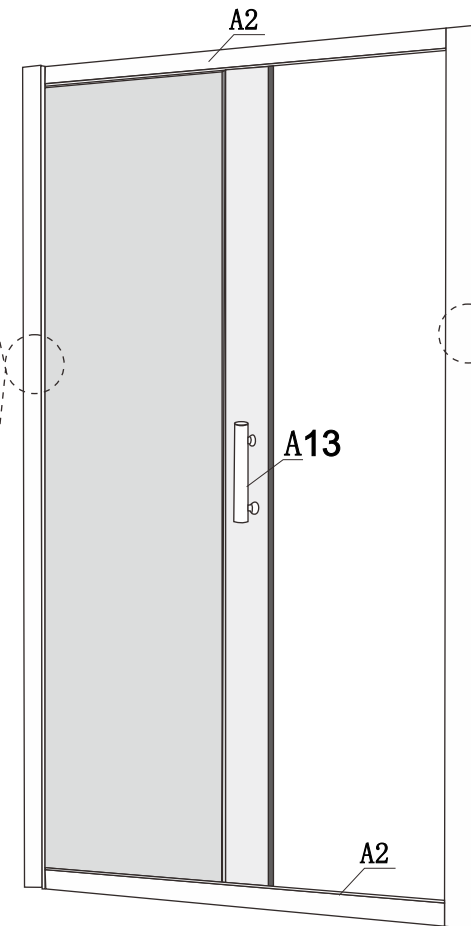
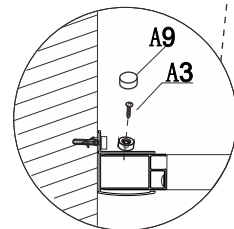
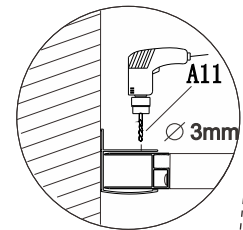
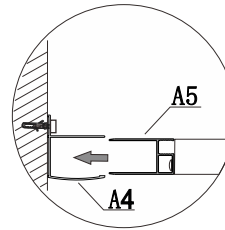
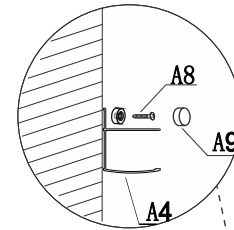
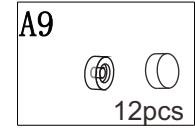
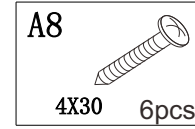
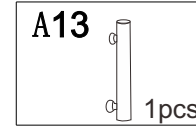
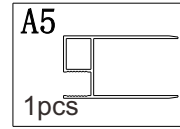
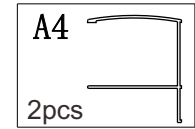
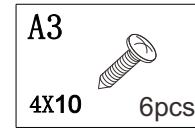
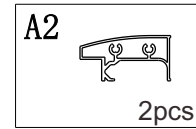
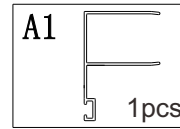

6